

Hydra-Cell®

Seal-less Pumps



Hydra-Cell F/M/D/H Series Seal-less Pumps



Hydra-Cell T and Q Series Pumps

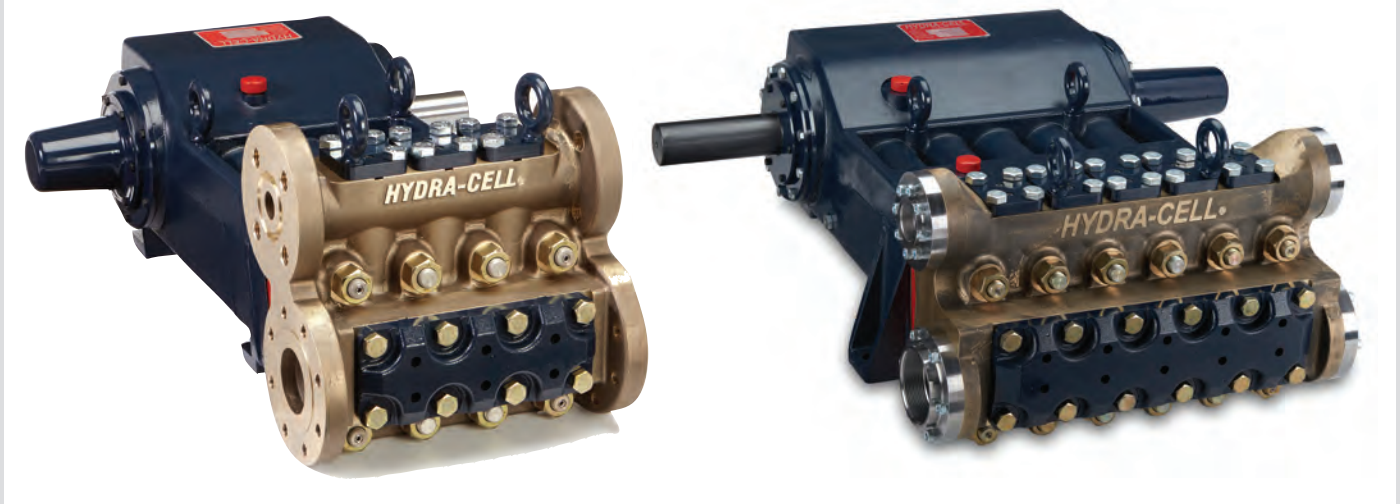

Hydra-Cell P Series Seal-less Metering Pumps

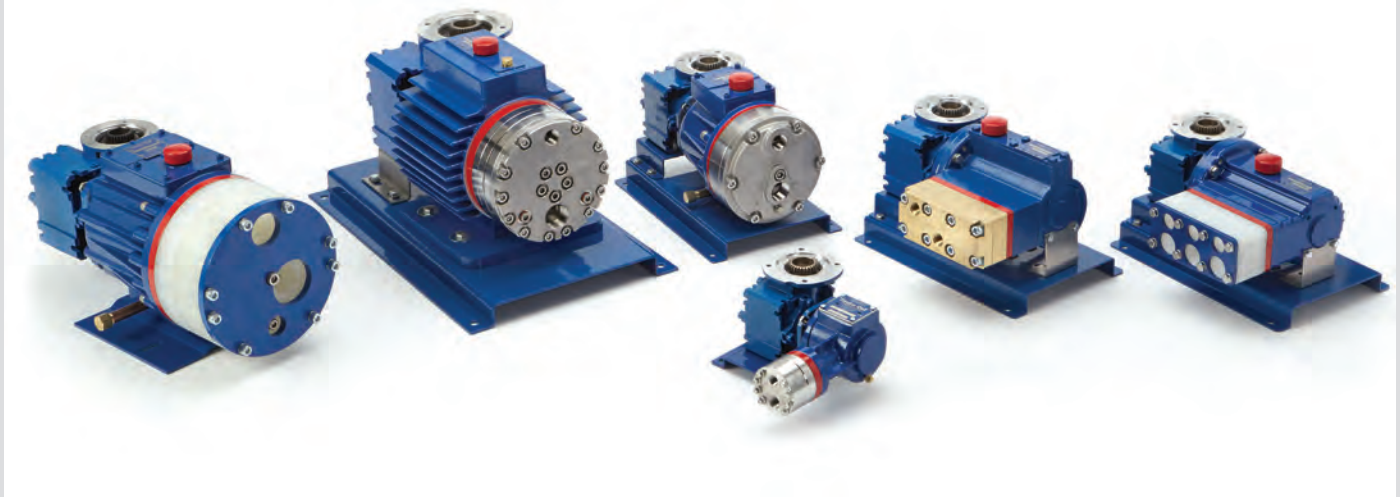

Due to the Wanner Engineering Continuous Improvement Program, specifications and other data in this catalog are subject to change.

Hydra-Cell® Provides Versatile, Reliable Performance



Seal-less Design Advantages

- Positive displacement pump with hydraulically balanced, unstressed diaphragms
- Seal-less design can handle abrasive particulates (up to 800 microns in size depending on model) and solids in suspension
- Wide range of flow capacities from 0.11 gpm (0.4 l/min) to 36.5 gpm (138 l/min) and pressure ratings to 2500 psi (172 bar)
- Heavy-duty construction for long service life in harsh conditions
- Flexible installation with a variety of mounting configurations
- Repeatable, accurate output with smooth, virtually pulse-free flow
- High efficiency, low power consumption
- Minimal maintenance, no mechanical seals, cups, or packing to leak, wear, or replace
- Can run dry without damage to the pump

Fluid Handling Capability

From thin liquids to highly viscous resins and slurries, Hydra-Cell pumps can handle the full spectrum of process fluids while maintaining high-efficiency operation. This includes non-lubricating fluids as well as fluids with abrasives that can damage or destroy other types of pumps.

Primary Pumping Applications

- Adding
- Blending
- Cleaning
- Cooling
- Coating
- Dosing
- Filling
- Filtering
- Injecting
- Metering
- Mixing
- Spraying
- Transferring

Materials of Construction Selection

- Metallic pump heads in seven types of materials to handle higher pressures and non-metallic pump heads in two types of materials to process corrosive or aggressive fluids at lower pressures.
- Diaphragms and corresponding o-rings in six types of elastomeric materials.
- Valve assemblies in a wide range of metallic and non-metallic materials to suit specific process applications. Includes valve seats, valves, valve springs, and valve spring retainers.



Propane/ Butane Freon Ammonia Polymers Fuels/ Additives D.I. Water Glycols Chlorine Acids/ Caustics Glues/ Adhesives Inks/ Paints Resins Slurries

Hydra-Cell® Principles of Operation

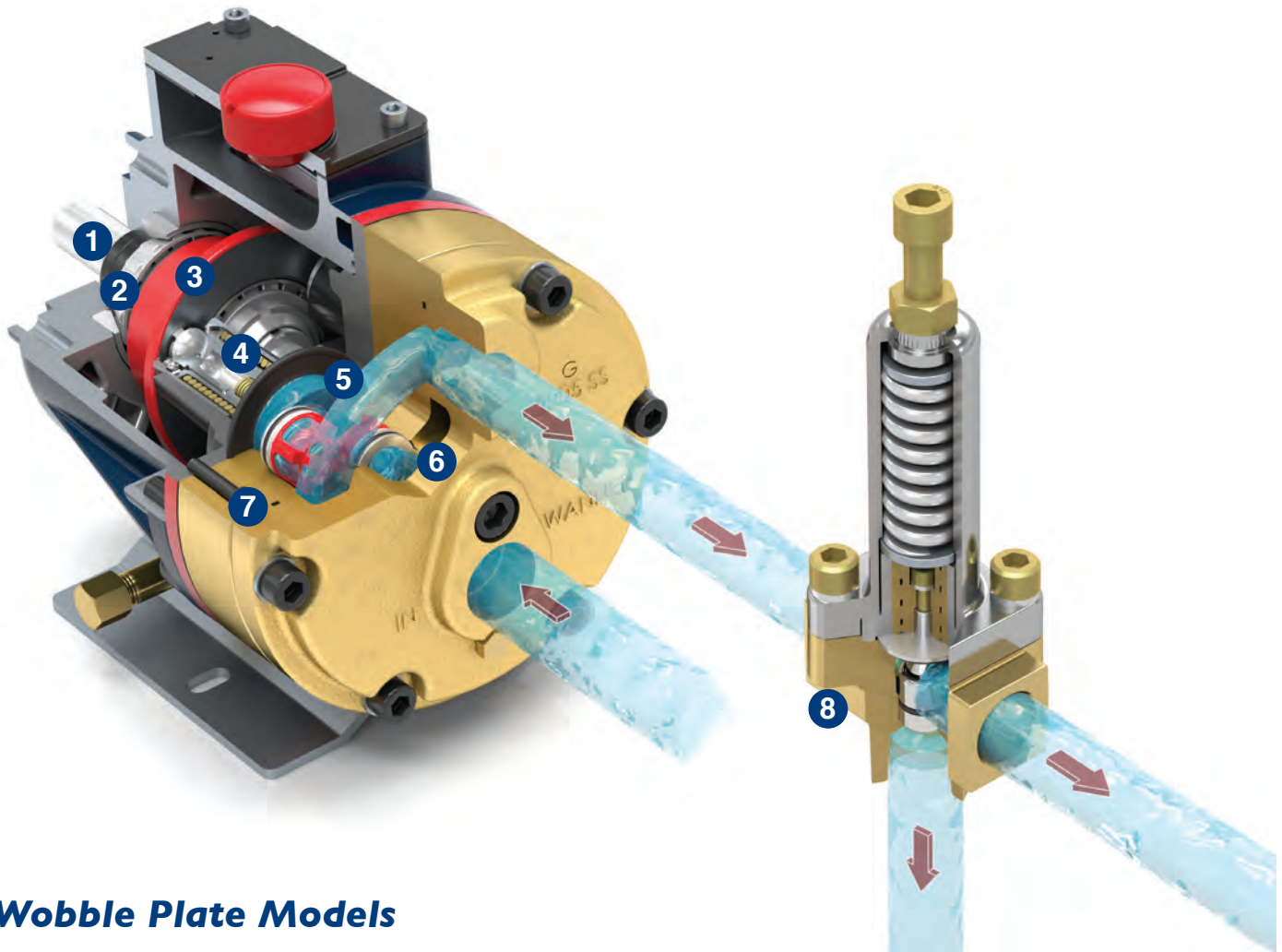

Wobble Plate Models

- 1 Drive Shaft:** via electric motor, hydraulic motor, belt and pulley, etc.
- 2 Tapered Roller Bearings:** rigid support, immersed in lubricating oil bath
- 3 Fixed Angle Cam/Wobble Plate:** translates rotary motion into linear to the hydraulic cells
- 4 Hydraulic Cells (patented):** displace diaphragms via pressurized oil
- 5 Diaphragms:** hydraulic balanced, no stress during flexing
- 6 Inlet Valve Assembly:** simple design, allows liquid into pump chamber
- 7 Discharge Valve Assembly:** allows liquid to flow into pressure discharge line
- 8 C62 Pressure Regulating Valve:** controls output pressure and prevents pump overload

Patented Kel-Cell® Diaphragm Protection

Kel-Cell Diaphragm Position Control (DPC) technology protects Hydra-Cell Pumps by safeguarding the diaphragms



against abnormal or adverse conditions (e.g. blocked pipe or filter, inadequate liquid supply or discharge pressure).

The Kel-Cell positioning system stabilizes the diaphragms and virtually eliminates the possibility of incidental diaphragm failure. Kel-Cell is available with Hydra-Cell models M03/D03, D10, H25, D35, and D66 as well as Hydra-Cell Metering Solutions models P400 and P600.

Hydra-Cell® Principles of Operation

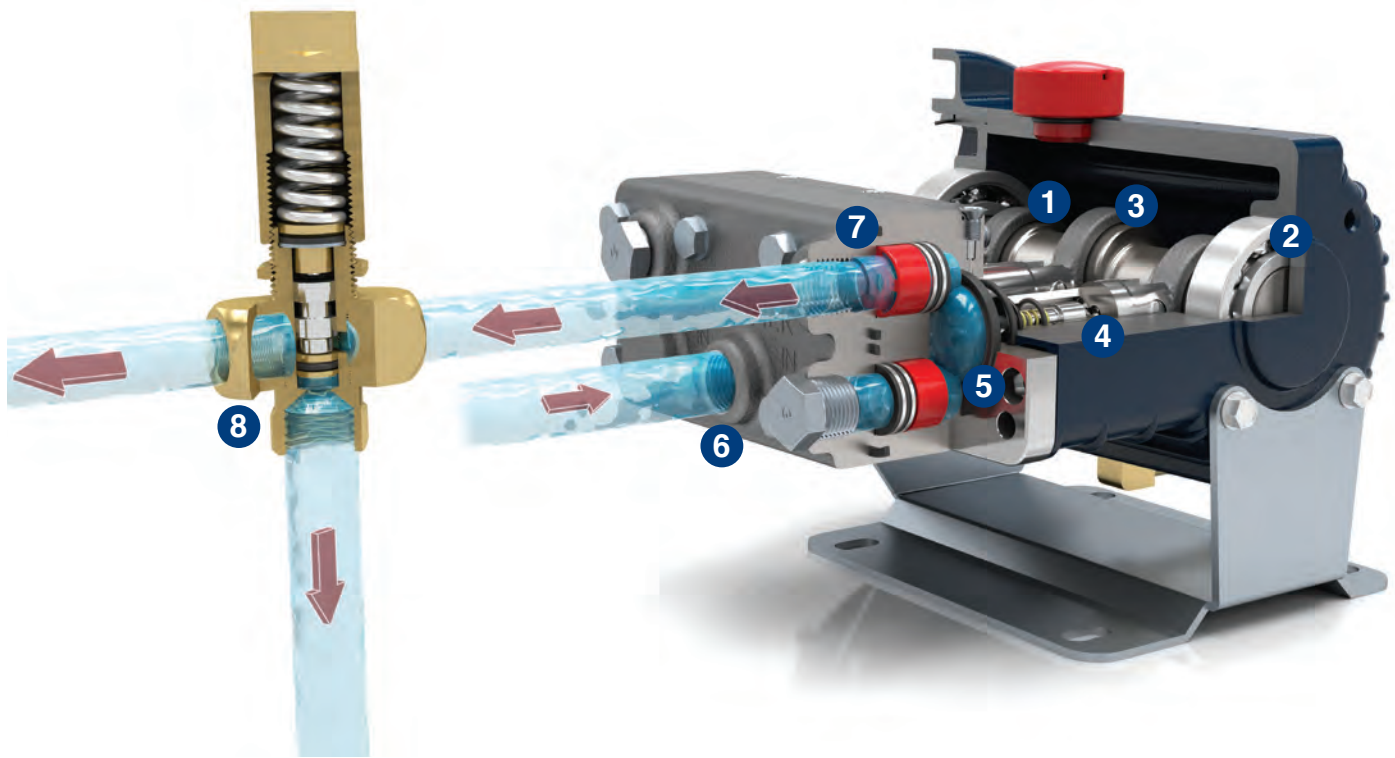

Crank-shaft Models

- 1 **Drive Shaft:** via electric motor, hydraulic motor, belt and pulley, etc.
- 2 **Precision Ball Bearings:** rigid support, immersed in lubricating oil bath
- 3 **Connecting Rods:** hardened, precision ground, and polished
- 4 **Hydraulic Cells (patented):** displace diaphragms via pressurized oil
- 5 **Diaphragms:** hydraulically balanced, no stress during flexing
- 6 **Inlet Valve Assembly:** simple design, allows liquid into pump chamber
- 7 **Discharge Valve Assembly:** allows liquid to flow into discharge pressure line
- 8 **C46 Pressure Regulating Valve (In-line):** controls output pressure and prevents pump overload

Hydra-Cell® Flow Capacities and Pressure Ratings

F/M/D/H Series Seal-less Pumps

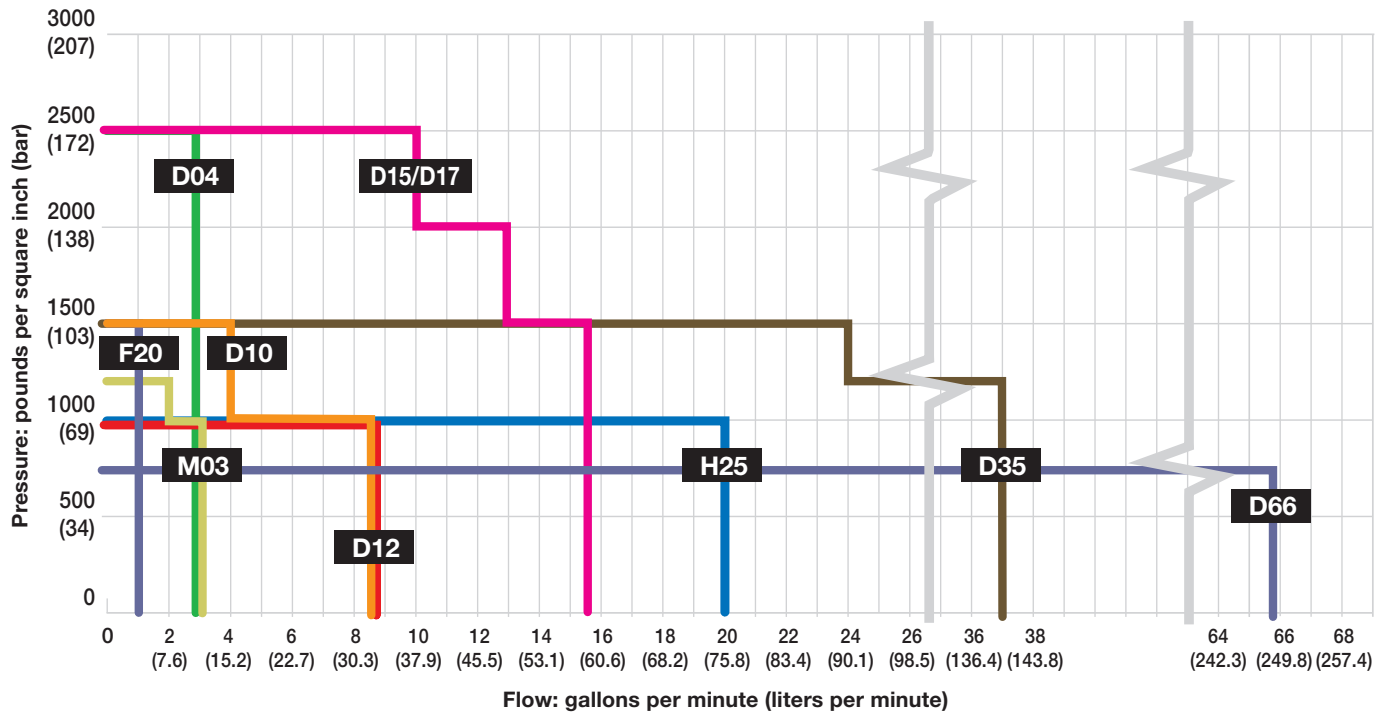

The graph above displays the maximum flow capacity at a given pressure for each model series. The table below lists the maximum flow capacity and maximum pressure capability of each model series.

Please Note: Some models do not achieve maximum flow at maximum pressure. Refer to the individual model Performance graphs on subsequent pages for precise flow and pressure capabilities by specific pump configuration.

Model	Maximum Capacity gpm (l/min)	Maximum Discharge Pressure psi (bar)		Maximum Operating Temperature F (C) ²		Maximum Inlet Pressure psi (bar)
		Non-metallic ¹	Metallic	Non-metallic	Metallic	
F20	1.0 (3.8)	350 (24)	1500 (103)	140° (60°)	250° (121°)	250 (17)
M03	3.1 (11.7)	350 (24)	1200 (83)	140° (60°)	250° (121°)	250 (17)
D04	2.9 (11.2)	N/A	2500 (172)	N/A	250° (121°)	500 (34)
D10	8.8 (33.4)	350 (24)	1500 (103)	140° (60°)	250° (121°)	250 (17)
D12	8.8 (33.4)	N/A	1000 (69)	N/A	250° (121°)	250 (17)
D15 & D17	15.5 (58.7)	N/A	2500 (172)	N/A	250° (121°)	500 (34)
H25	20.0 (75.9)	350 (24)	1000 (69)	140° (60°)	250° (121°)	250 (17)
D35	36.5 (138)	N/A	1500 (103)	N/A	250° (121°)	500 (34)
D66	65.7 (248.7)	250 (17)	700 (48)	140° (60°)	250° (121°)	250 (17)

¹ 350 psi (24 bar) maximum with PVDF liquid end; 250 psi (17 bar) maximum with Polypropylene liquid end.

² Consult factory for correct component selection for temperatures from 160°F (71°C) to 250°F (121°C).

F20 Series

Maximum Flow Rate: 1.0 gpm (3.8 l/min)
 Maximum Pressure: 1500 psi (103 bar) for Metallic Pump Heads
 350 psi (24 bar) for Non-metallic Pump Heads



F20 Close-coupled for 56C frame motors shown. F21 models are shaft-driven. F22 models are flexible-coupled to 56C, 143TC and 145TC frame motors. Pump head materials include (metallic) Brass, 316L Stainless Steel and Hastelloy C and (non-metallic) Polypropylene and PVDF.

Maximum Flow at Designated Pressure

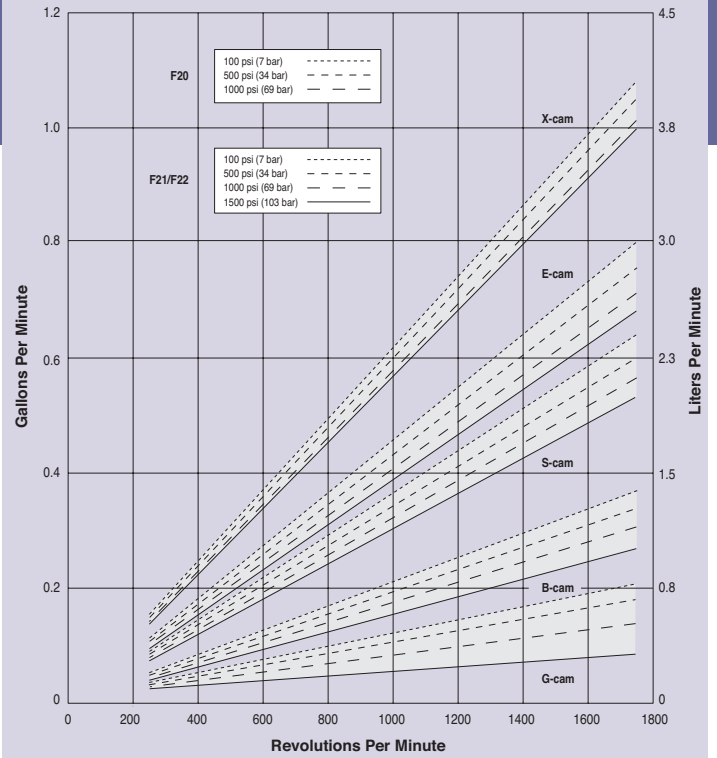

S, B & G cam options based on 10 psi (0.7 bar) inlet pressure.

M03 Series

Maximum Flow Rate: 3.1 gpm (11.7 l/min)
 Maximum Pressure: 1200 psi (83 bar) for Metallic Pump Heads
 350 psi (24 bar) for Non-metallic Pump Heads



M03 Close-coupled with Polypropylene pump head. Also available in (metallic) Brass, 316L Stainless Steel, Hastelloy C and (non-metallic) Polypropylene and PVDF pump heads.



D03 Shaft-driven with Stainless Steel pump head.

Maximum Flow at Designated Pressure

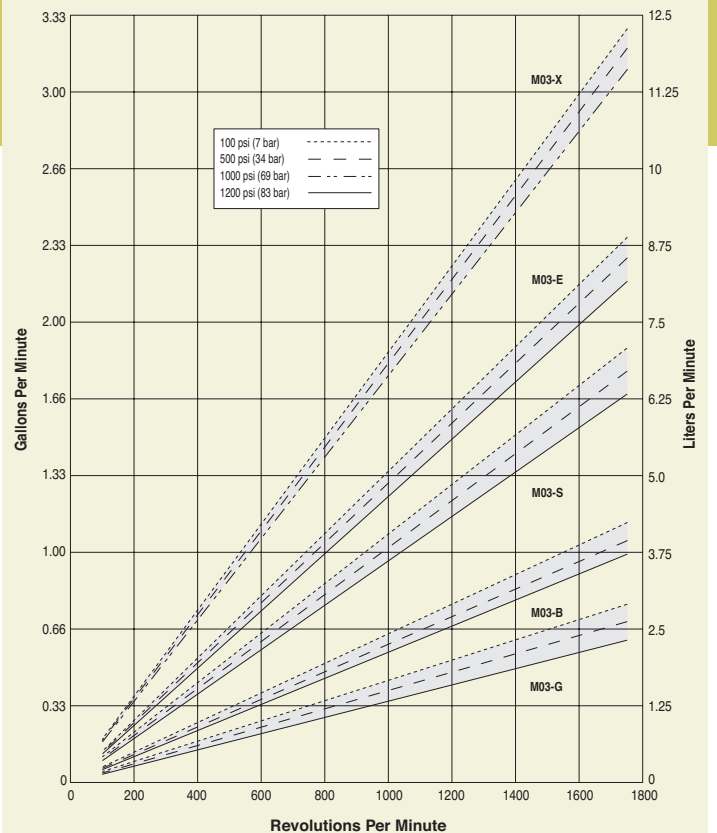

M03 Mono-Block Series

Maximum Flow Rate: 3.1 gpm (11.7 l/min)
 Maximum Pressure: 1000 psi (69 bar) for Metallic Pump Heads



Mono-Block (M03) Close-coupled with Stainless Steel pump head. Also available in Brass.

Maximum Flow at Designated Pressure

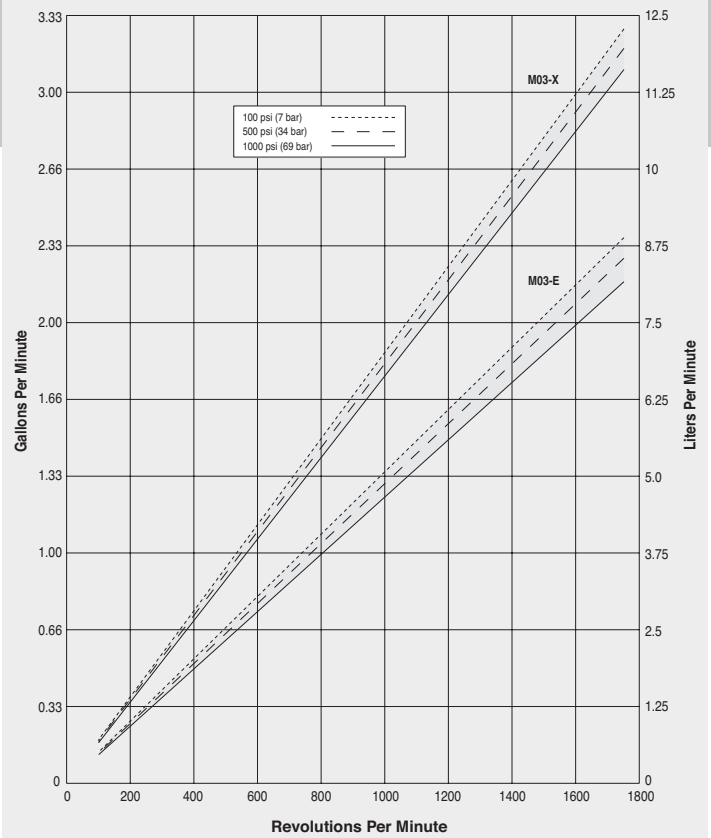

D04 Series

Maximum Flow Rate: 2.9 gpm (11.2 l/min)
 Maximum Pressure: 2500 psi (172 bar) for Metallic Pump Heads



D04 Shaft-driven with Stainless Steel pump head. Also available in Brass and 304 or 316L Stainless Steel pump heads.

Maximum Flow at Designated Pressure

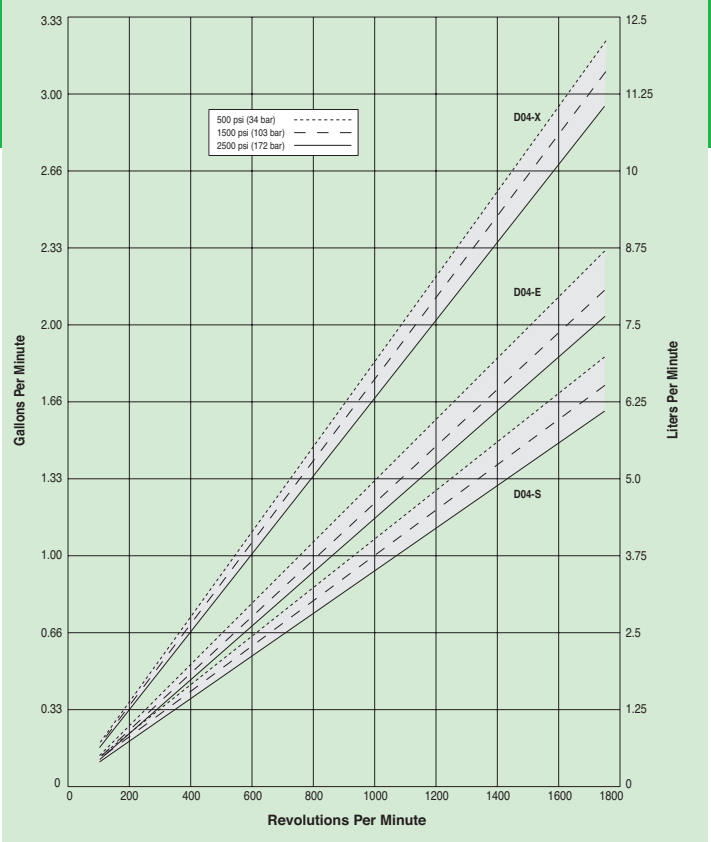

D10 Series

Maximum Flow Rate: 8.8 gpm (33.4 l/min)
 Maximum Pressure: 1500 psi (103 bar) for Metallic Pump Heads
 350 psi (24 bar) for Non-metallic Pump Heads



D10 with Cast Iron pump head. Also available in (metallic) Brass, Duplex Alloy 2205, 316L Stainless Steel (with ANSI flanges), 316L Stainless Steel, Hastelloy C and (non-metallic) Polypropylene and PVDF pump heads.

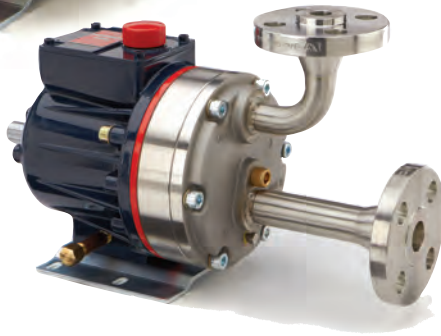

D10 with Stainless Steel pump head and ANSI flanges

Maximum Flow at Designated Pressure

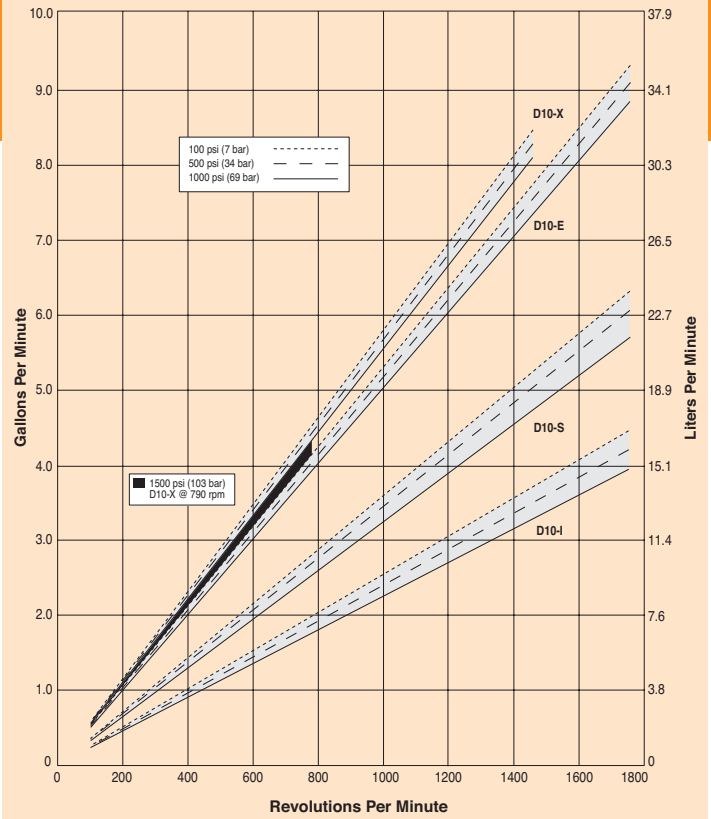

D12 Series

Maximum Flow Rate: 8.8 gpm (33.4 l/min)
 Maximum Pressure: 1000 psi (69 bar) for Metallic Pump Heads



D12 equipped with Model C62 Pressure Regulating Valve. Available in Brass, Cast Iron, and 316L Stainless Steel pump heads.

Maximum Flow at Designated Pressure

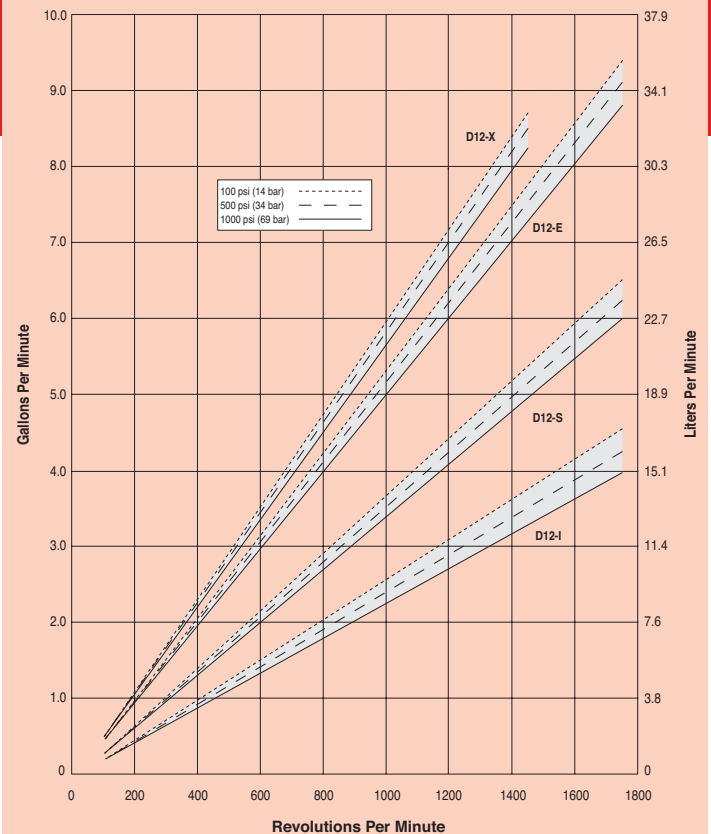

D15/D17 Series

Maximum Flow Rate: 15.5 gpm (58.7 l/min)
 Maximum Pressure: 2500 psi (172 bar) for Metallic Pump Heads



D15 for horizontal installations shown with Stainless Steel pump head.

D17 for vertical mounting (including motor adapter, base plate and oil reservoir) shown with Brass pump head.

Maximum Flow at Designated Pressure

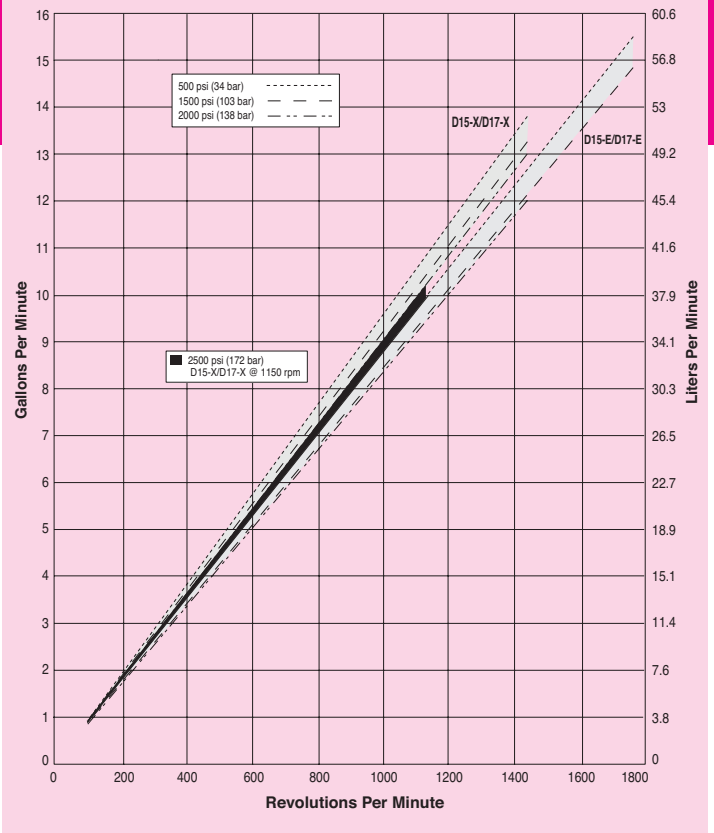

H25 Series

Maximum Flow Rate: 20.0 gpm (75.9 l/min)
 Maximum Pressure: 1000 psi (69 bar) for Metallic Pump Heads
 350 psi (24 bar) for Non-metallic Pump Heads

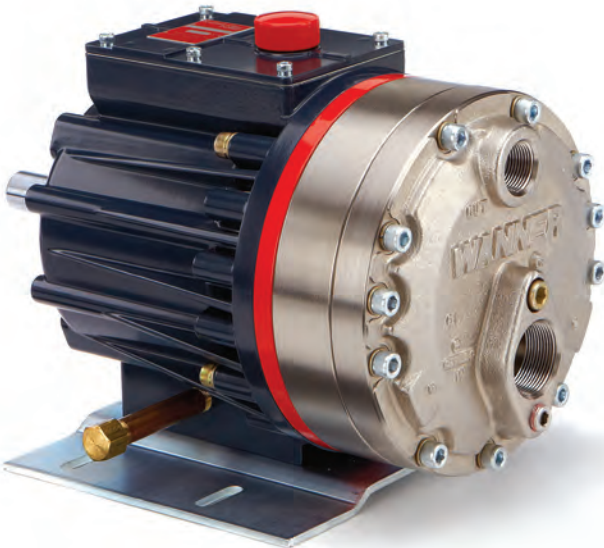

H25 with Cast Iron pump head. Also available in (metallic) Brass, Duplex Alloy 2205, 316L Stainless Steel (with ANSI flanges), 316L Stainless Steel and (non-metallic) Polypropylene and PVDF pump heads.

Maximum Flow at Designated Pressure

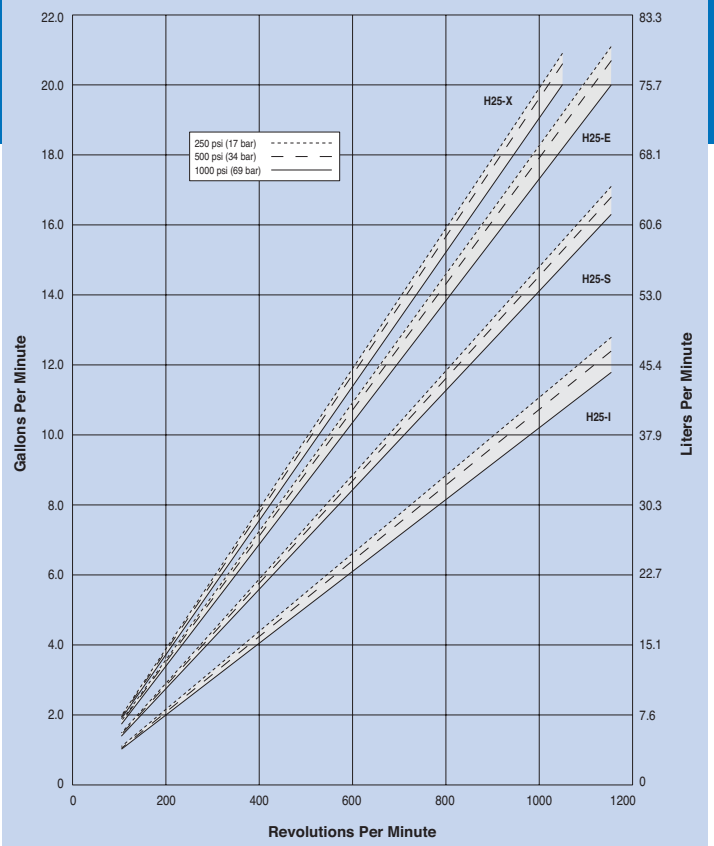

D35 Series

Maximum Flow Rate: 36.5 gpm (138 l/min)
 Maximum Pressure: 1500 psi (103 bar) for Metallic Pump Heads



D35 with Stainless Steel pump head and SAE flanges. Also available in Brass, Cast Iron, Duplex Alloy 2205, 316 Stainless Steel (with ANSI flanges), 316L Stainless Steel and Hastelloy C pump heads.

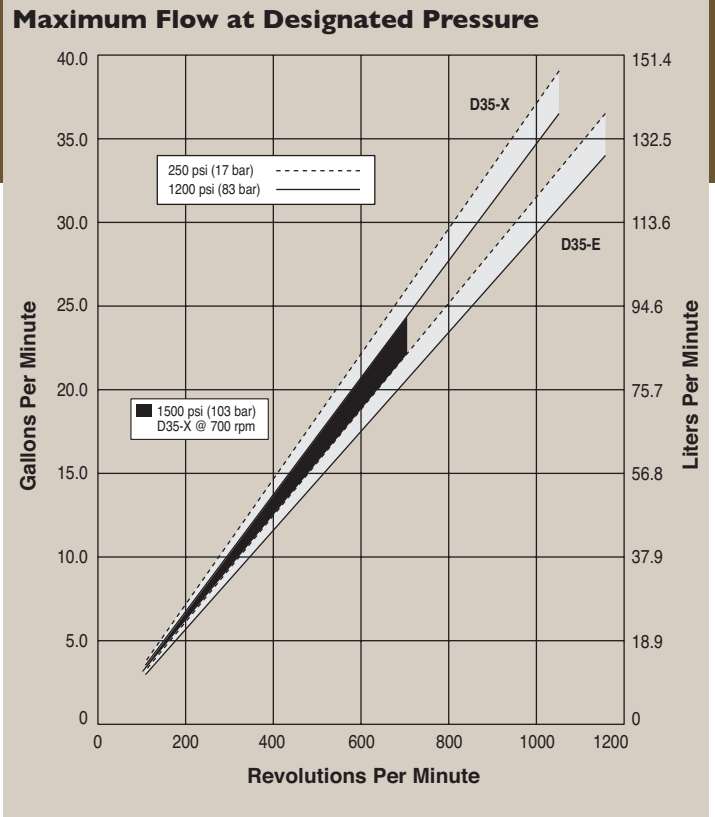

D66 Series

Maximum Flow Rate: 65.7 gpm (248.7 l/min)
 Maximum Pressure: 700 psi (48 bar) for Metallic Pump Heads
 250 psi (17 bar) for Non-metallic Pump Heads



D66 with Polypropylene pump head. Also available in Bronze and Stainless Steel pump heads.

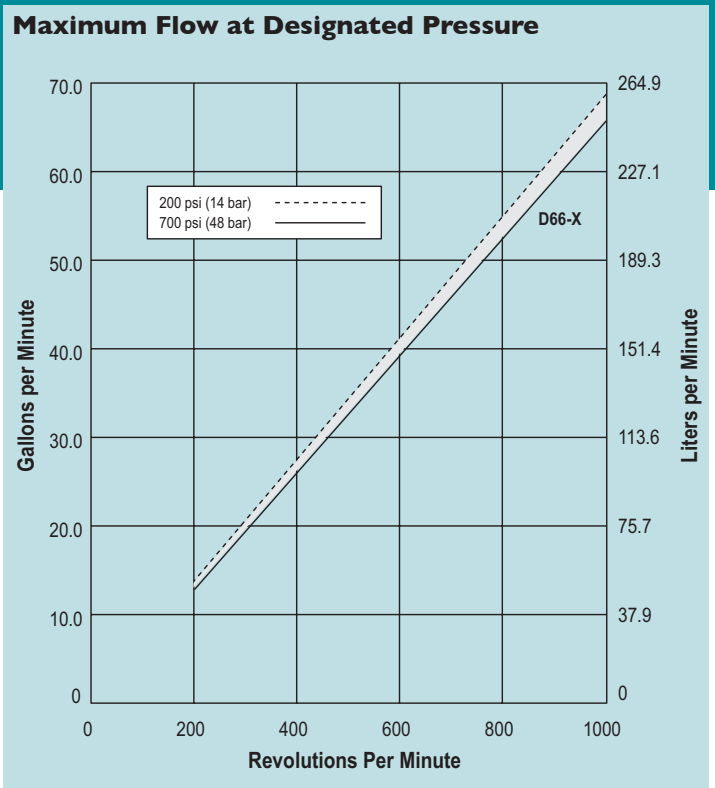

C Series Pressure Regulating Valves

Designed for use with any positive displacement pump, Hydra-Cell C Series pressure regulating valves bypass system fluid to prevent excess system pressure. They can also be used as pressure relief valves.

Performance Advantages

- Accurate and repeatable
- Adjustable
- Immediate response
- Smooth, chatter-free bypass
- No external springs or moving parts
- Flow-through design with minimal pressure surge
- Heavy-duty construction
- Easy to service in place



C60 Series valves feature a seal-less diaphragm with a tapered plunger, making the valves ideal for high-pressure requirements and handling dirty fluids.



Tapered design of the C20 Series valves plunger.

C20 Series

For use with Hydra-Cell models D10, D12, H25, and D35.

C22 valve with Brass body (also available in Stainless Steel and Hastelloy C).



C46 Series

For use with Hydra-Cell models F20, F21, F22, M03, D03, and M03 Mono-Block.



C46 In-line with Brass body.



C46 Off-line with Stainless Steel body (also available in Brass).

C60 Series

For use with Hydra-Cell models D04, D10, D12, D15/D17, H25, and D35.

C62 Seal-less valve with Stainless Steel body (also available in Brass and Hastelloy C).



Hydra-Cell® Pumps Accessories and Options



C80 Series Air Bleed Valves



Pulsation Dampeners



HDD Series (horizontal direct drive) with Orange Coupling Guard, Motor, and Base



HFD Series (horizontal direct drive) with Flanged Adapter, Motor, and Base



HBD Series (horizontal belt drive) with Belt Pulley Guard, Motor, and Base



Controllers



Control Freak™ Touch-screen Metering Controller



Hydra-Oil Lubricants, Motor Adapters, Oil Reservoir Sight Bottles, Tool Kits, and Couplings



Replacement Parts Kits

Hydra-Cell® Flow Capacities and Pressure Ratings

T100 Series High-horsepower Pumps

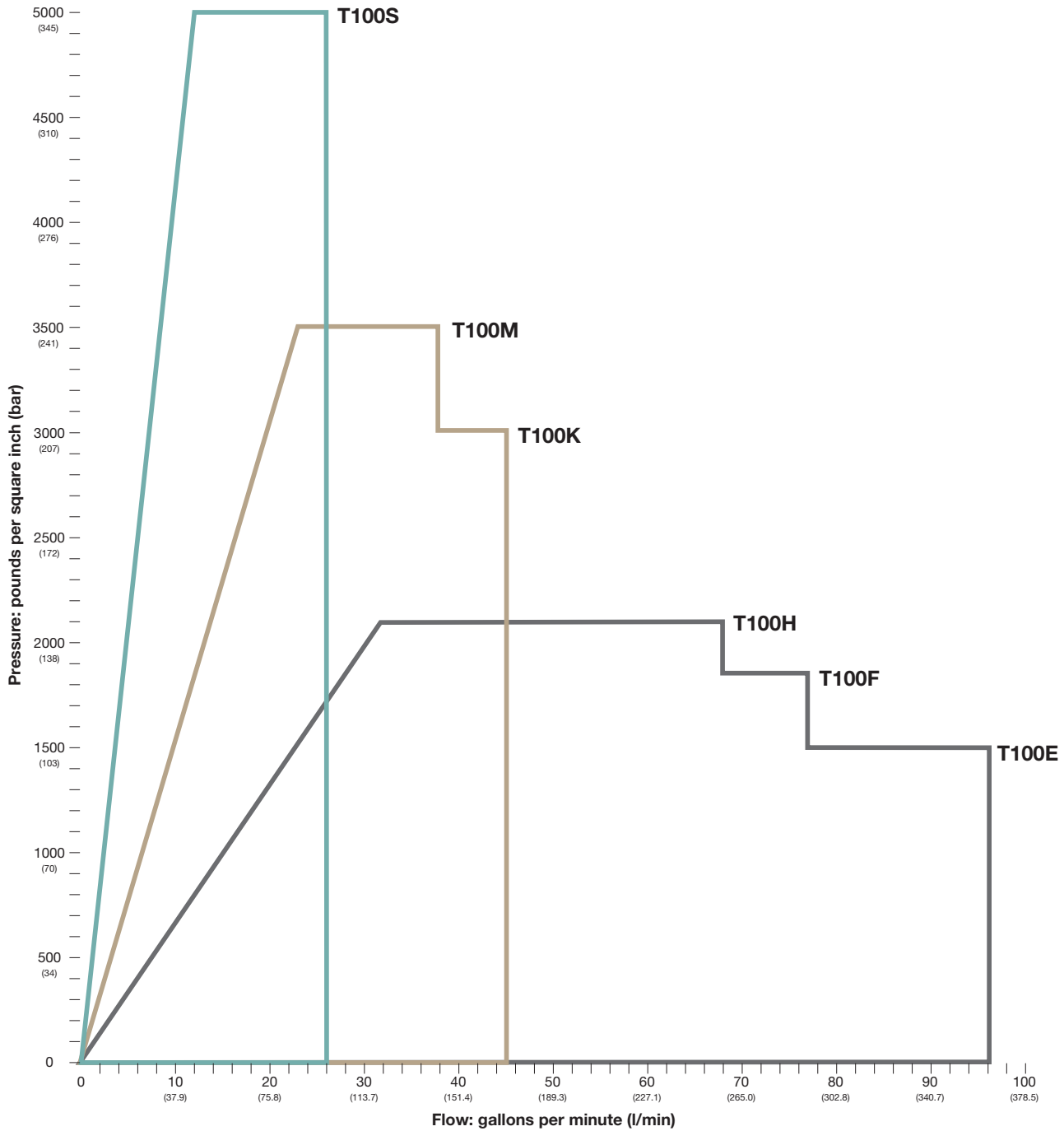

Model	Maximum Capacity		Maximum Discharge Pressure		Maximum Inlet Pressure		Maximum Operating Temperature	
	(gpm)	(l/min)	(psi)	(bar)	(psi)	(bar)	(F)*	(C)*
T100S	26.0	98.4	5000	345	500	34	180°	82°
T100M	38.0	143.8	3500	241	500	34	180°	82°
T100K	45.0	170.4	3000	207	500	34	180°	82°
T100H	68.0	257.8	2100	145	500	34	180°	82°
T100F	76.5	289.6	1850	128	500	34	180°	82°
T100E	96.0	366.1	1500	103	500	34	180°	82°

* Consult factory for correct component selection for temperatures above 180°F (82°C) or below 40°F (4°C)

T100 Series High-horsepower Pumps

Available
to Meet
API 674!

High Pressure Model

Model T100S

Maximum Flow Rate: 26.0 gpm (98.4 l/min) 891 BPD
Maximum Pressure: 5000 psi (345 bar) for Metallic Pump Heads

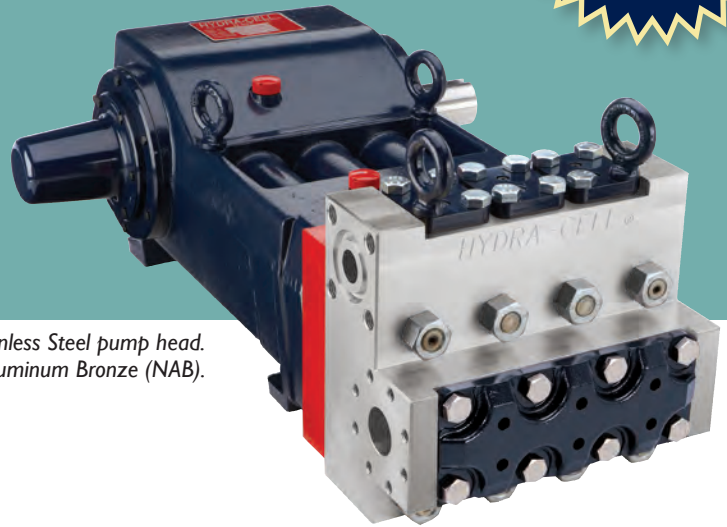

High-pressure model with Stainless Steel pump head.
Also available in Nickel Aluminum Bronze (NAB).

Medium Pressure Models

Model T100K

Maximum Flow Rate: 45.0 gpm (170.4 l/min) 1543 BPD
Maximum Pressure: 3000 psi (207 bar) for Metallic Pump Heads

Model T100M

Maximum Flow Rate: 38.0 gpm (143.8 l/min) 1303 BPD
Maximum Pressure: 3500 psi (241 bar) for Metallic Pump Heads



Medium-pressure model with Nickel Aluminum Bronze (NAB) pump head.
Also available in Stainless Steel.

Low Pressure Model

Model T100E

Maximum Flow Rate: 96.0 gpm (366.1 l/min) 3316 BPD
Maximum Pressure: 1500 psi (103 bar) for Metallic Pump Heads

Model T100F

Maximum Flow Rate: 76.5 gpm (289.6 l/min) 3497 BPD
Maximum Pressure: 1850 psi (128 bar)

Model T100H

Maximum Flow Rate: 68.0 gpm (257.8 l/min) 3108 BPD
Maximum Pressure: 2100 psi (145 bar)

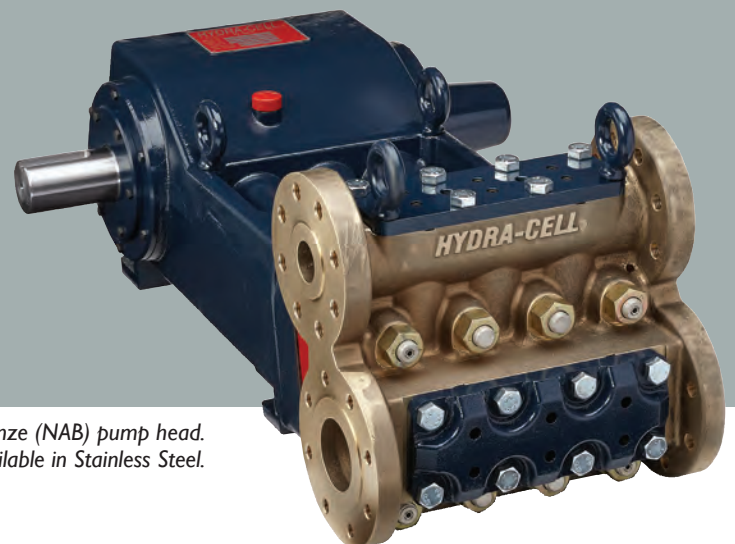

Low-pressure model with Nickel Aluminum Bronze (NAB) pump head.
Also available in Stainless Steel.

Hydra-Cell® Flow Capacities and Pressure Ratings

Q155 Series Quintuplex Pumps

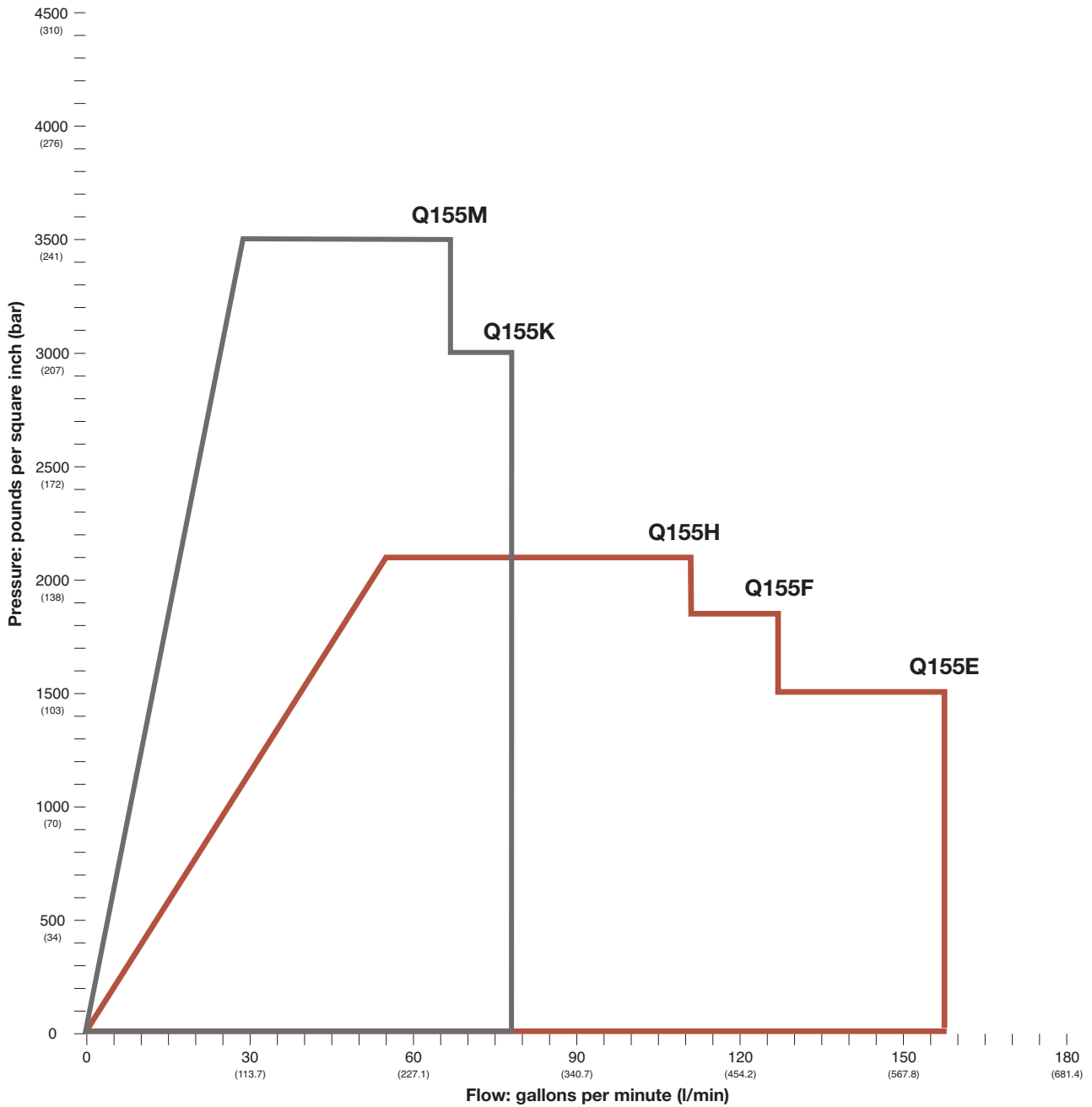

Model	Maximum Capacity		Maximum Discharge Pressure		Maximum Inlet Pressure		Maximum Operating Temperature	
	(gpm)	(l/min)	(psi)	(bar)	(psi)	(bar)	(F)*	(C)*
Q155M	67	252	3500	241	500	34	180°	82°
Q155K	78	295	3000	207	500	34	180°	82°
Q155H	111	421	2100	144	500	34	180°	82°
Q155F	127	490	1850	127	500	34	180°	82°
Q155E	157	595	1500	103	500	34	180°	82°

* Consult factory for correct component selection for temperatures above 180°F (82°C) or below 40°F (4°C)

Q155 Series Quintuplex Pumps

Medium Pressure Models

Model Q155K

Maximum Flow Rate: 78.0 gpm (295.3 l/min) 2674 BPD
Maximum Pressure: 3000 psi (207 bar) for Metallic Pump Heads

Model Q155M

Maximum Flow Rate: 66.8 gpm (252.9 l/min) 2290 BPD
Maximum Pressure: 3500 psi (241 bar) for Metallic Pump Heads



Q155 Quintuplex pump with Nickel Aluminum Bronze pump head. Also available in Stainless Steel.

Low Pressure Models

Model Q155E

Maximum Flow Rate: 157 gpm (595 l/min) 5383 BPD
Maximum Pressure: 1500 psi (103 bar) for Metallic Pump Heads

Model Q155F

Maximum Flow Rate: 127 gpm (490 l/min) 4354 BPD
Maximum Pressure: 1850 psi (127 bar) for Metallic Pump Heads

Model Q155H

Maximum Flow Rate: 111 gpm (421 l/min) 3806 BPD
Maximum Pressure: 2100 psi (144 bar) for Metallic Pump Heads



Q155 Quintuplex pump with Nickel Aluminum Bronze pump head. Also available in Stainless Steel.

Hydra-Cell® P Series Metering Pumps



P100



P200

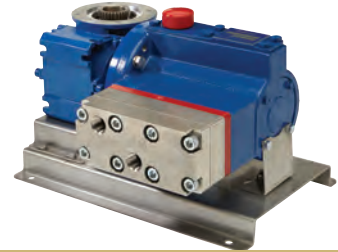

P300



P400



P500



P600

P Series Flow Capacities and Pressure Ratings

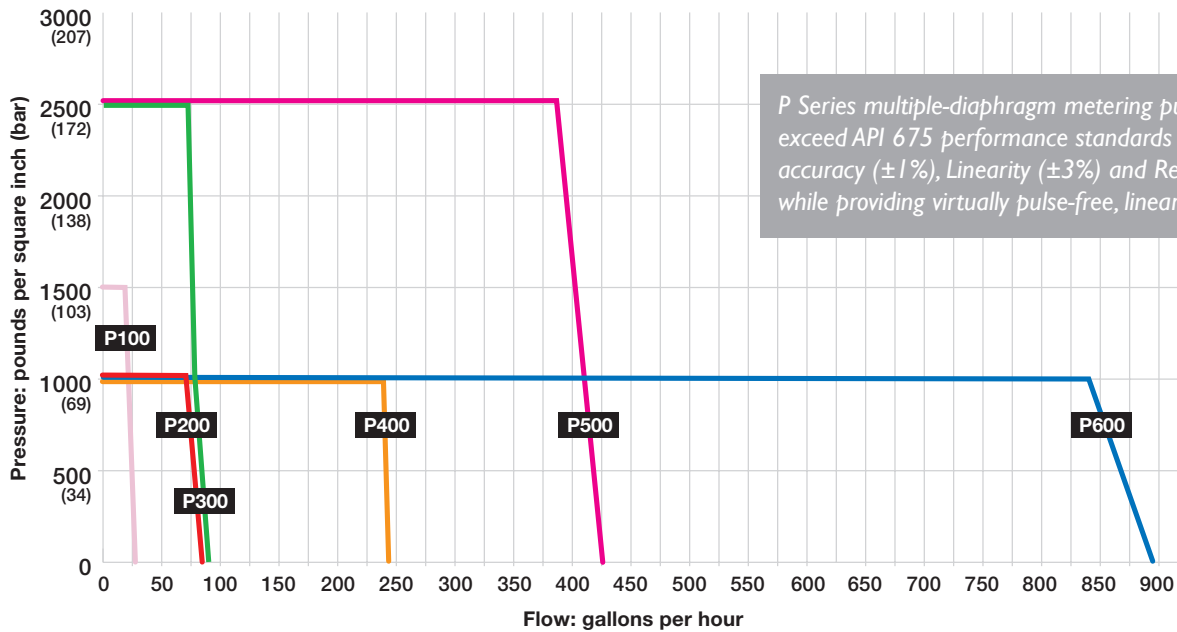

P Series multiple-diaphragm metering pumps meet or exceed API 675 performance standards for Steady-state accuracy ($\pm 1\%$), Linearity ($\pm 3\%$) and Repeatability ($\pm 3\%$) while providing virtually pulse-free, linear flow.

Model ¹	Maximum Capacity gph	Maximum Discharge Pressure psi (bar)		Maximum Operating Temperature F (C) ³		Maximum Inlet Pressure psi (bar)
		Non-metallic ²	Metallic	Non-metallic ²	Metallic	
P100	27.0	350 (24)	1500 (103)	140° (60°)	250° (121°)	250 (17)
P200	81.0	350 (24)	1000 (69)	140° (60°)	250° (121°)	250 (17)
P300	81.4	N/A	2500 (172)	N/A	250° (121°)	500 (34)
P400	242.8	350 (24)	1000 (69)	140° (60°)	250° (121°)	250 (17)
P500	425.9	N/A	2500 (172)	N/A	250° (121°)	500 (34)
P600	890.3	350 (24)	1000 (69)	140° (60°)	250° (121°)	250 (17)

¹ Ratings are for X-cam design.

² 350 psi (24 bar) maximum with PVDF liquid end; 250 psi (17 bar) maximum with Polypropylene liquid end.

³ Consult factory for correct component selection for temperatures from 160°F (71°C) to 250°F (121°C).

Hydra-Cell® MT8 Series Metering Pump

This groundbreaking triplex metering pump is the latest addition to the Hydra-Cell Metering Solutions product line.

The MT8 meets or exceeds API 675 performance standards for Steady-State Accuracy ($\pm 1\%$), Linearity ($\pm 3\%$) and Repeatability ($\pm 3\%$).

Hydraulically-balanced and actuated, the pump features an internal relief valve for added safety and cartridge check valves for ease of maintenance.

Minimum Flow Rate: 0.06 gph (0.227 lph)
 Maximum Flow Rate: 8.00 gph (30.28 lph)
 Maximum Pressure: 3500 psi (241 bar) for Metallic Pump Heads

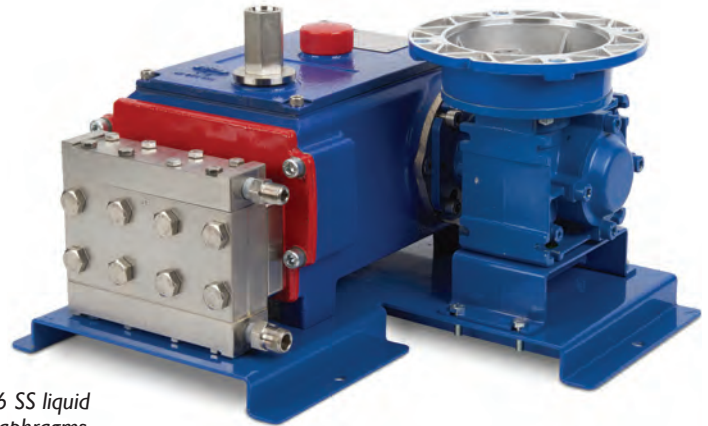

The MT8 is currently available with 316 SS liquid end and check valves plus PTFE diaphragms.

Hydra-Cell® S Series Metering Pumps

The S Series pumps provide an economical choice for chemical injection in metering applications.

Solenoid driven, the S pumps feature a wide discharge-volume range, extensive choice of liquid end materials, various control functions, and a wide voltage range.

Materials of construction choices and versatile design options result in pumps perfected for specific applications including general chemicals, high-pressure boiler, high-viscosity fluids, outgassing and more.

Flow Rate	SM Series Models	SP/ST/SA Series Models
30 ml/min	SM030	SP/ST/SA-030
60 ml/min	SM060	SP/ST/SA-060
100 ml/min	SM100	SP/ST/SA-100
200 ml/min	N/A	SP/ST/SA-200
With Relief Valve		
30 ml/min	SM03R	SP/ST/SA-03R
60 ml/min	SM06R	SP/ST/SA-06R
100 ml/min	SM10R	SP/ST/SA-10R



SM030CAS manual control with stroke speed dial.



SP060HVS digital with pulse-in control.



SP03RKPS digital with pulse-in control and timer.



SA03RPES digital with pulse-in and analog-in.

Hydra-Cell®

Seal-less Pumps

Wanner Engineering, Inc.

World Headquarters & Manufacturing
Wanner Engineering Inc.
1204 Chestnut Avenue,
Minneapolis, MN 55403 USA
Phone: 612-332-5681 • Fax: 612-332-6937
Toll-Free (USA): 800-332-6812
Email: sales@wannereng.com
www.Hydra-Cell.com

Regional Office

207 US Highway 281
Wichita Falls, TX 76310 USA
Phone: 940-322-7111
Toll-Free: 800-234-1384
Email: sales@wannereng.com
www.Hydra-Cell.com

Latin American Office

R. Álvaro Anes, 150 Bairro Campestre
Santo André/São Paulo, Brazil CEP 09070-030
Phone: +55 (11) 4081-7098
Email: mmagoni@wannereng.com
www.Hydra-Cell.com

Wanner International Ltd.

Wanner International Ltd.
Hampshire - United Kingdom
Phone: +44 (0)1252 816847
Email: sales@wannerint.com
www.Hydra-Cell.eu



上海陶文机电科技有限公司

Shanghai inscription on pottery mechanical and electrical technology co., LTD

上海市闵行区沪光东路88号305室
邮编: 201100
Room 305 No.88, Huguang East Road,
Minhang District, Shanghai 201100

Tel: 021-52271371
Fax: 021-52271371*208
Mobile: 139 1661 9634
E-mail: 13916619634@163.com

